

# Residual Gas Analyzers

RGA100/200/300 — 100 amu, 200 amu and 300 amu systems

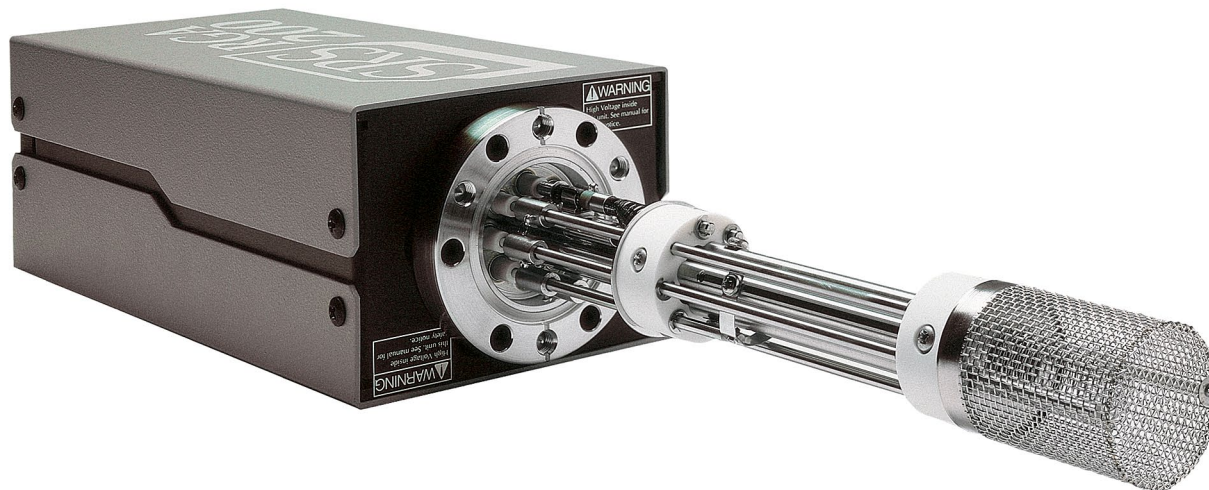

## SRS Residual Gas Analyzers

- **100, 200 and 300 amu systems**
- **Better than 1 amu resolution**
- **6 decades of dynamic range**
- **$5 \times 10^{-14}$  Torr detection limit**
- **RGA Windows & LabVIEW software**
- **Field-replaceable electron multiplier and filament**
- **RS-232 interface**

- **RGA100 ... \$3750** (U.S. list)
- **RGA200 ... \$4750** (U.S. list)
- **RGA300 ... \$6250** (U.S. list)

The 100, 200 and 300 amu residual gas analyzers from SRS offer exceptional performance and value. These RGAs provide detailed gas analysis of vacuum systems at about half the price of competitive models. Each RGA system comes complete with a quadrupole probe, electronics control unit (ECU), and a real-time Windows software package that is used for data acquisition and analysis, as well as probe control.

### Rugged Probe Design

The probe consists of an ionizer, quadrupole mass filter, and a detector. The simple design has a small number of parts which minimizes outgassing and reduces the chances of introducing impurities into your vacuum system. The probe assembly is rugged and mounts onto a standard 2.75" Conflat® flange. It is enclosed within a stainless steel tube, with the exception of the ionizer which requires just 2.5" of clearance in your vacuum system — about that of a standard ion gauge. The probe is designed using self-aligning parts so it can easily be reassembled after cleaning.

### Compact Electronics Control Unit

The densely packed ECU contains all the necessary electronics for controlling the RGA head. It is powered by either an external +24 VDC (2.5 A) power supply or an optional, built-in power module which plugs into an AC outlet. LED indicators provide instant feedback on the status of the electron multiplier, filament, electronics system and the

probe. The ECU can easily be removed from the probe for high-temperature bakeouts.

### Unique Filament Design

A long-life, dual thoriated-iridium ( $\text{ThO}_2/\text{Ir}$ ) filament is used for electron emission. Dual  $\text{ThO}_2/\text{Ir}$  filaments last much longer than single filaments, maximizing the time between

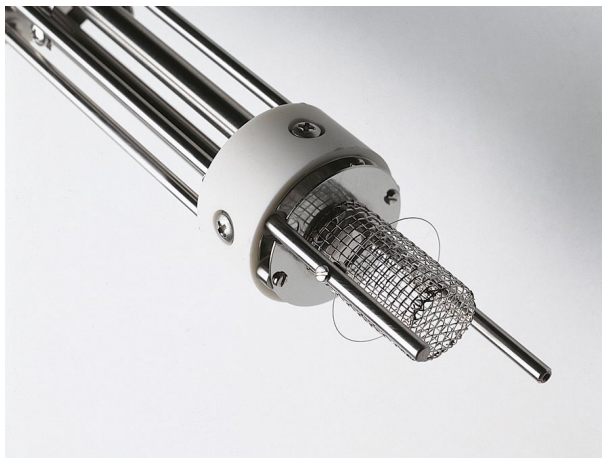

*Dual  $\text{ThO}_2/\text{Ir}$  filament*

filament replacement. Unlike other designs, SRS filaments can be replaced by the user in a matter of minutes.

### Continuous Dynode Electron Multiplier

A Faraday cup detector is standard with all SRS RGAs, allowing partial pressure measurements from  $10^{-5}$  Torr to  $5 \times 10^{-11}$  Torr. For increased sensitivity and faster scan rates,

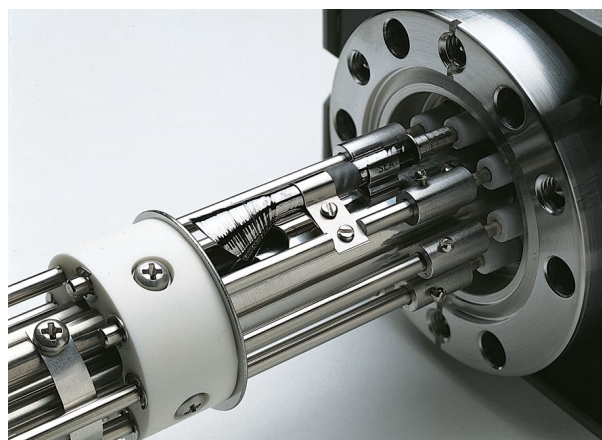

*Continuous dynode electron multiplier*

an optional electron multiplier is offered that detects partial pressures down to  $5 \times 10^{-14}$  Torr. This state-of-the-art, multi-

channel, continuous-dynode electron multiplier (EM) offers increased longevity and stability, and can also be replaced by the user — a first for RGAs.

### Useful Features

SRS RGAs have a built-in degassing feature. Using electron impact desorption, the ion source is thoroughly cleaned, greatly reducing the ionizer's contribution to background noise.

A firmware driven filament protection feature constantly monitors (675 Hz) for over pressure. If over pressure is detected, the filament is immediately shut off, preserving its life.

A unique temperature-compensated, logarithmic electrometer detects ion current from  $10^{-7}$  to  $10^{-15}$  amps in a single scan, with better than 2 % precision. This huge dynamic range means you can make measurements of small and large gas concentrations simultaneously.

### Complete Programmability

Communication with computers is made via the RS-232 interface. Analog and histogram (bar) scans, leak detection, and probe parameters are all controlled and monitored through a high-level command set. This allows easy integration into existing programs.

### RGA Windows Software

The RGA systems are supported with a real-time Windows software package that runs on PCs. The intuitive graphical user interface allows measurements to be made quickly

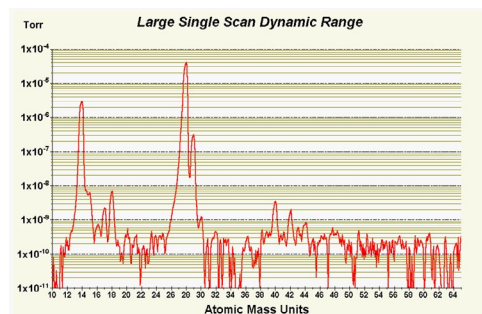

*RGA Windows software — Analog mode*

and easily. The program is fully interactive, giving the user complete control of the graphical display. Screens can be split for dual-mode operation, scales can be set to linear or log format, and data can be scaled manually or automatically. Data is captured and displayed in real time or scheduled for acquisition at a given time interval for long-term data logging. Features include user-selectable units (Torr, mbar, Pa and A), programmable audio and visual alarms, and comprehensive on-line help.

## RGA100/200/300 Residual Gas Analyzers

The software also allows complete RGA head control with easy mass scale tuning, sensitivity calibration, ionizer setup, and electron-multiplier gain adjustment. For further analysis, data files can be saved in ASCII format for easy transfer into spreadsheets. Graphic images can be saved as META files or copied to the clipboard for importing directly into other Windows programs. The software also provides password protection for locking out head parameters so that casual users can't alter important settings. A LabVIEW driver is also available on the SRS website.

An optional stand-alone monitor (PPM100) can be used to control the RGA without a host computer.

### Multi-Head Operation

The software supports multiple head operation when more than one RGA is needed. Up to eight ECUs can be monitored from the software.

### Performance and Value

The SRS family of RGAs is ideal for applications involving gas analysis, leak detection, and vacuum processing. We offer 100, 200 and 300 amu systems with supporting Windows software, and options that include an electron multiplier and a built-in power module for AC line operation. The RGA Windows software is available on the web at [www.thinkSRS.com](http://www.thinkSRS.com).



*RGA rear panel  
(without AC power module)*



*RGA rear panel  
(with AC power module)*

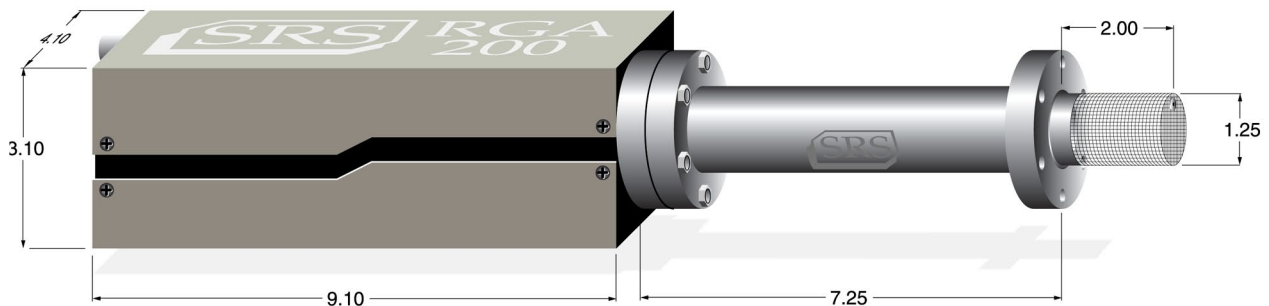

*RGA dimensional drawing (inches)*

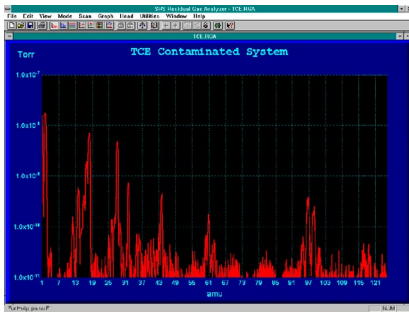

**Analog mode** provides a line graph representation of the acquired mass spectrum (partial pressure vs. mass number). Span, resolution and noise floor can each be set. Scans can be single-shot, timed or taken continuously.

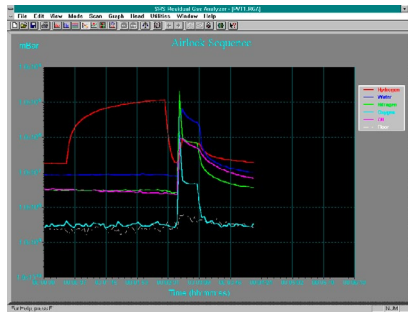

**Pressure vs. time** presents a strip chart of partial pressures for selected masses, and provides a complete time history of your data. Complete scrolling and zoom control is available even while data is being acquired. This mode is most often used for monitoring process trends.

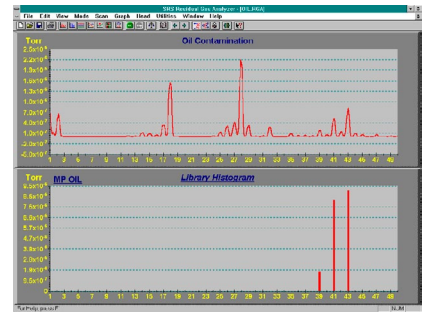

**Library mode** contains a comprehensive list of gases that can be used to compare against the current spectrum. A search mode allows you to select up to 12 masses and identify and display (numerically and graphically) the intensity of all gases that contain these masses.

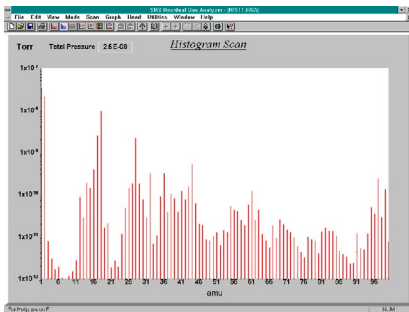

**Histogram mode** displays a bar graph of partial pressure vs. mass, allowing the spectrum to easily be interpreted. This mode is often used for quick and easy vacuum analysis. The screen can be split for viewing two modes of operation simultaneously.

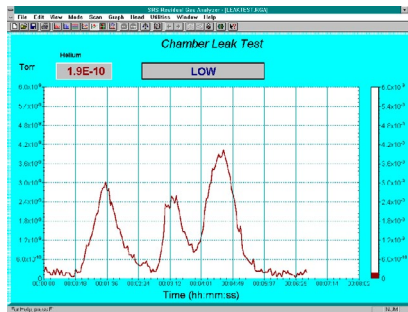

**Leak detection mode** monitors a particular mass number (not just helium) over time, and combines many features of the previous modes. A vertical bar graph provides a visual reference for viewing changes in intensity from a distance. A programmable audible tone, large numeric read-out, and visual alarm are also provided.

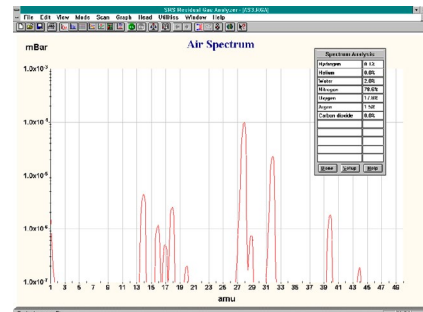

**Analysis utility** provides an approximation of the composition of gases being monitored by the RGA. Since more than one gas can contribute to a particular amu's partial pressure, the analysis mode is extremely useful in determining the make-up of complex gases. Up to 12 common gases can be selected for the analysis.

Ch#	Name	Mass	Value	Alarm	Speed	Cal	CEM
1	Hydrogen	2	3.8E-07	NORMAL	1	1.00	OFF
2	Water	18	7.1E-08	LOW	1	1.00	OFF
3	Nitrogen	28	1.4E-05	LOW	1	1.00	OFF
4	Oxygen	32	4.5E-10	NORMAL	3	1.00	ON
5	CO2	44	3.4E-11	NORMAL	3	1.00	ON
6	Oil	55	1.0E-12	NORMAL	3	1.00	ON
10	Floor	21	1.5E-13	NORMAL	1	1.00	ON

**Table mode** provides a readout of mass, scaling factor, and true partial pressure. The display shows the peak heights and alarm status of up to 10 masses. The electron multiplier can be independently set on or off for each mass. This allows the user to view minor species even in the presence of high total pressure.

Ch#	Name	Value	Alarm
1	Hydrogen	1.1E-07	NORMAL
2	Water	5.6E-08	HIGH
3	Nitrogen	1.4E-08	NORMAL
4	Oxygen	2.9E-09	NORMAL
5	Oil	1.4E-08	EXTREME HIGH
10	Floor	3.0E-09	OFF

**Annunciator mode** is provided for conveniently monitoring up to 10 masses. If a particular mass has tripped its preset alarm, the large box will turn red indicating a problem. An audible alarm will also be present until the mass falls back within its preset limits. This mode is most often used for Go/No-Go testing.

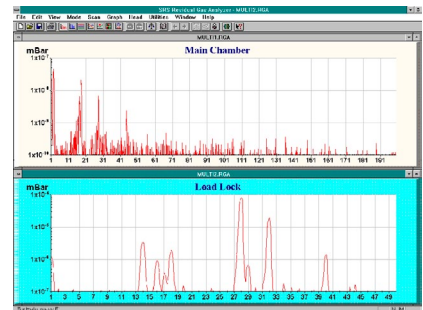

**Multi-head operation** is available when more than one RGA is needed for analysis. Up to eight heads can be monitored simultaneously from the software.

## RGA100/200/300 Specifications

### Operational

Mass range	
RGA100	1 to 100 amu
RGA200	1 to 200 amu
RGA300	1 to 300 amu
Mass filter type	Quadrupole
Detector type	Faraday cup (FC), standard Electron multiplier (EM), optional
Resolution	Better than 0.5 amu @ 10% peak (per AVS std. 2.3) height. Adjustable to constant peak width throughout the mass range.
Sensitivity (A/Torr)	$2 \times 10^{-4}$ (FC), <200 (EM). User adjustable throughout high voltage range. Measured with N <sub>2</sub> @ 28 amu with 1 amu full peak width, 10% height, 70 eV electron energy, 12 eV ion energy, and 1 mA electron emission current.
Minimum detectable partial pressure	$5 \times 10^{-11}$ Torr (FC), $5 \times 10^{-14}$ Torr (EM) Measured with N <sub>2</sub> @ 28 amu with 1 amu full peak width, 10% height, 70 eV electron energy, 12 eV ion energy, and 1 mA electron emission current.
Operating range	10 <sup>-4</sup> Torr to UHV (FC) 10 <sup>-6</sup> Torr to UHV (EM)
Operating temperature	70 °C (max.)
Bakeout temperature	300 °C (without ECU)

### Ionizer

Design	Open ion source, cylindrical symmetry, electron impact ionization
Material	SS304 construction
Filament	Thoriated iridium (dual) with firmware protection. Built-in 1 to 10 W degas ramp-up. (Field replaceable)
Electron energy	25 to 105 V, programmable
Ion energy	8 or 12 V, programmable
Focus voltage	0 to 150 V, programmable
Electron emission current	0 to 3.5 mA, programmable

### General

Probe dimension	8.75" from flange face to top of ionizer
Probe insertion	2.0"
Probe mounting flange	2.75" CF
Minimum tube I.D.	1.375"
ECU dimensions	3.1" × 4.1" × 9.1" (WHD). Easily separated from the probe for bakeout.
LED indicators	Power ON/OFF, filament ON/OFF, degas ON/OFF, electron multiplier ON/OFF, RS-232 Busy, Error, Overpressure, Burnt Filament
Warm-up time	Mass stability ±0.1 amu after 30 min.
Computer interface	RS-232C, 28,800 baud with high- level command set
Software	Windows based application
Power requirement	24 VDC @ 2.5 amps, male DB9 connector, optional built-in power module for AC line operation
Weight	6 lbs.
Warranty	One year parts and labor on defects in materials and workmanship

### Ordering Information

RGA100	100 amu RGA w/ RS-232	\$3750
RGA200	200 amu RGA w/ RS-232	\$4750
RGA300	300 amu RGA w/ RS-232	\$6250
Option 01	Electron multiplier	\$1500
Option 02	AC power module	\$250
Option 03	Ion counting output	\$250
O100HJR	200 °C heater jacket	\$450
O100MAX	Max. insertion nipple (4.5" CF)	\$600
O100REA	Ethernet adapter for RGA	\$495
O100EM	Replacement electron multiplier	\$1000
O100RF	Replacement ThO <sub>2</sub> /Ir filament	\$200
O100RI	Replacement ionizer kit (includes filament)	\$450
PPM100	Optional stand-alone monitor	\$2495

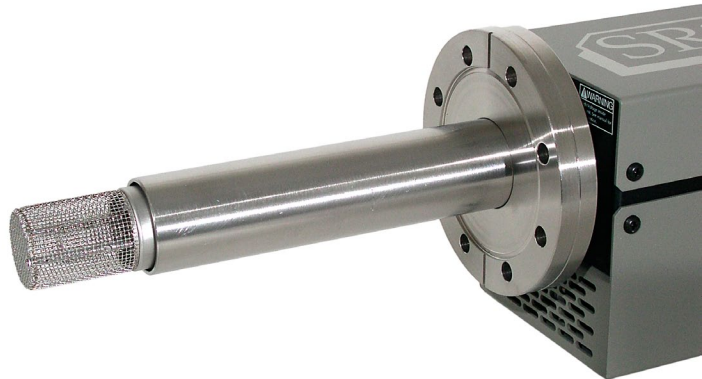

Maximum insertion nipple (O100MAX)